



**NEW! Now
with "Seal System"**

The complete range
TECE drainline shower channels

TECE:
Intelligent housing technology

TECEDrainline shower channels

TECEDrainline shower channels clear the bathroom of any items that get in the way, such as shower tubs and cubicles, and make it possible to uniformly design the floor. This gives rise to barrier-free bathrooms of generous proportions – real rooms for living in, in fact. TECEDrainline shower channels come either with stainless steel/glass covers or with the "plate" tileable channel where a plain slot in the floor is the only thing that can be seen.





Glass in the bathroom – timeless and high-class ...

With the new shower channel covers made of glass TECE opts for high-class materials in the bathroom.

The glass cover colour matches the glass covers of the TECEloop and TECESquare push plates. Available in the three colours white, green and black.





Still tough despite the transparent look: The safety glass sits on a particularly robust stainless steel support.

TECEdrainline glass

- Straight lengths 700, 800, 900, 1000, 1200, 1500 mm (nominal lengths)
- Visible width of 52 mm
- Withstands a 300 kg (load class K3)

The article numbers for your order and the required accessories can be found on pages 26 to 28 of this brochure.



Glass white



Glass green



Glass black

Like the "plate" tileable channel, the glass cover forms an enclosed surface that integrates seamlessly into the bathroom floor. The shower water flows off easily through a narrow drainage opening around the channel.

TECE provides the glass cover in standard colours green, black and white. The round-edged safety glass is permanently fixed to the underlying robust stainless steel support by means of a special adhesive.

TECEdrainline "plate" – tileable, elegant, unobtrusive ...

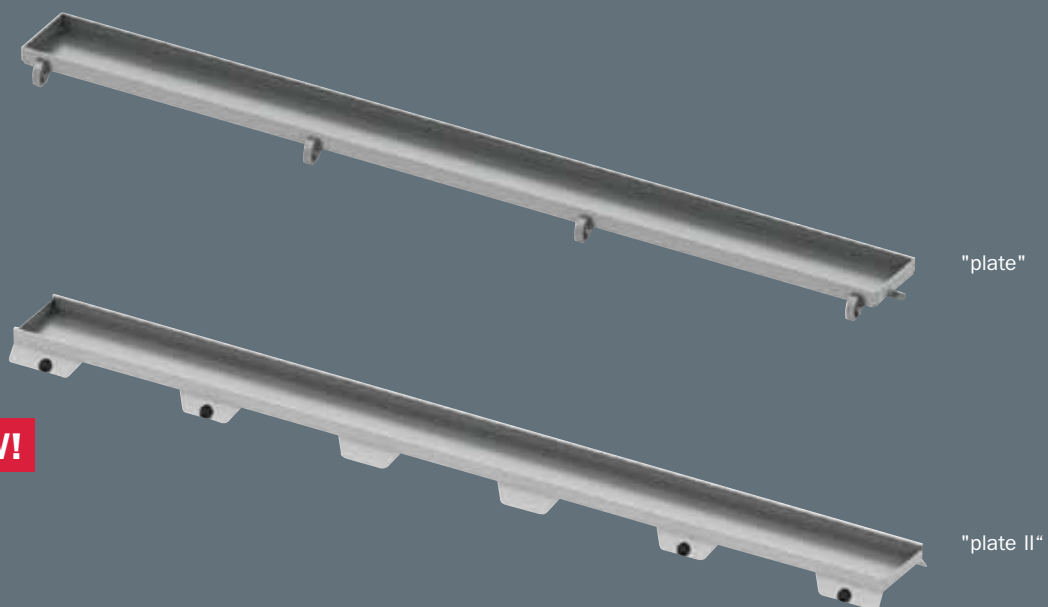

Thanks to the "plate" and "plate II" tileable channel, the TECEdrainline shower channel can be perfectly fitted into the flooring.

The tileable channel can also be provided for the angled channel in various dimensions (see Page 27).

TECEdrainline "plate"

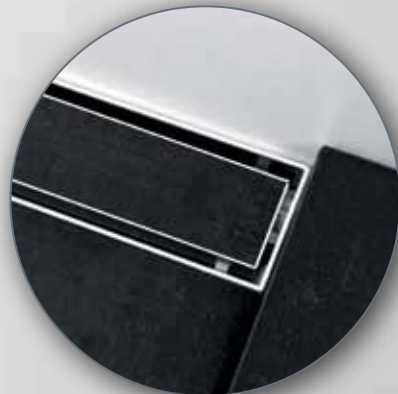

"plate"

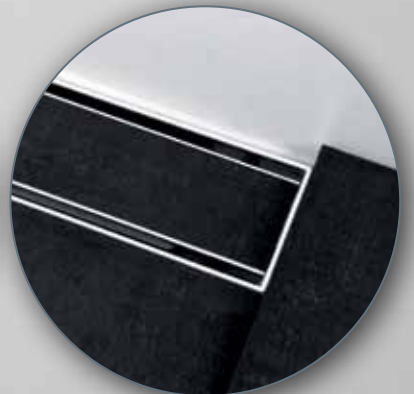

"plate II"



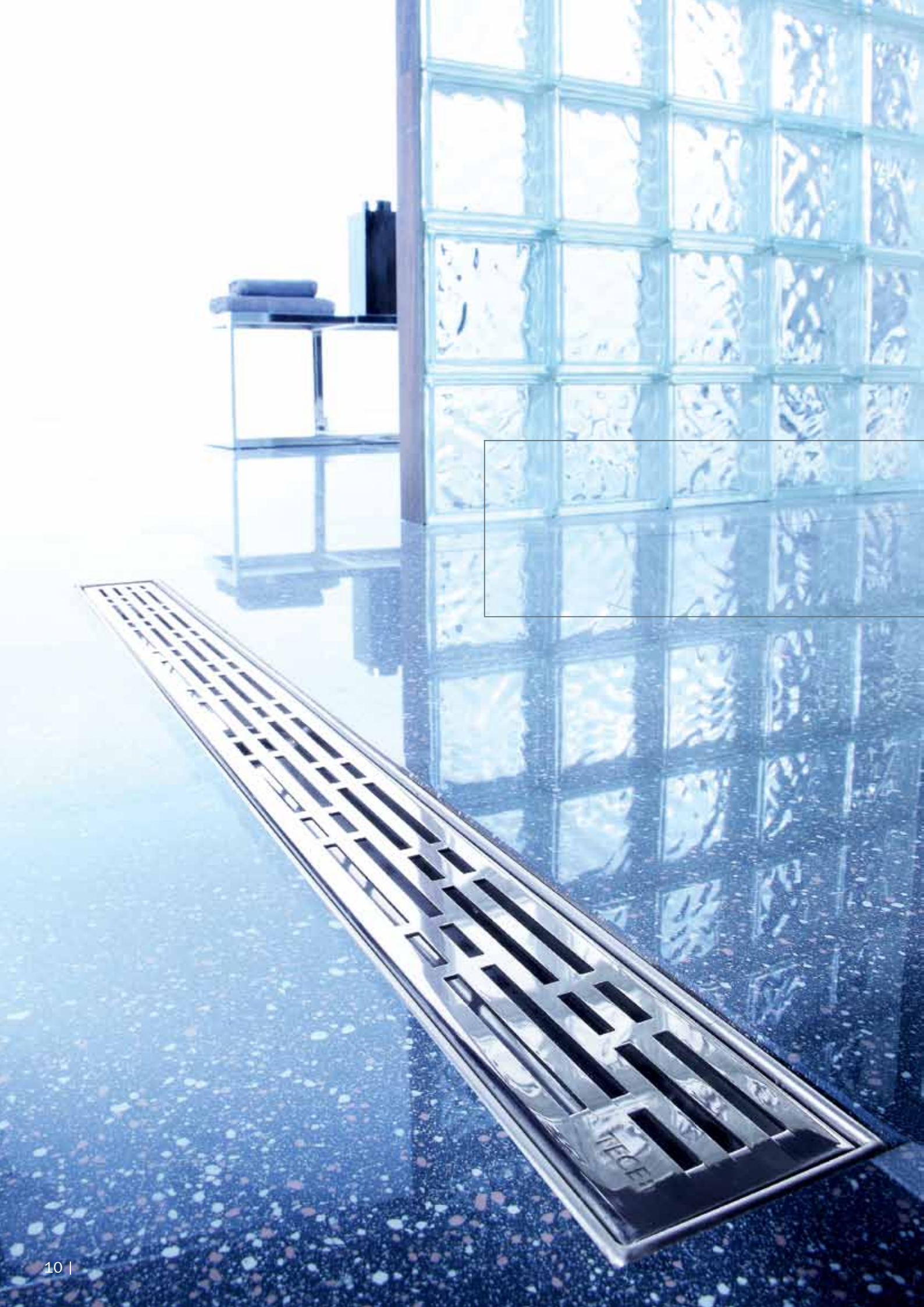

Set fresh nuances – with
TECEdrainline stainless steel grates.

Stainless steel is a material which is typically used in the bathroom: authentic, permanent and conveying a sense of value. The stainless steel grates are available in a variety of designs – and either brightly polished or mat brushed.

Stainless steel angled channels

Unique – the TECEdrainline angled channel range: Choose between two different design variants with polished stainless steel. The angled channel can also be obtained as a "plate" tileable channel. The grates can be provided up to a 1500 mm side length and can be loaded at up to 300 kg (load class K3).



The grates of the angled channels are made of bright polished stainless steel.

TECEdrainline stainless steel grates

Design "basic"



Design "lines"



Design "drops"

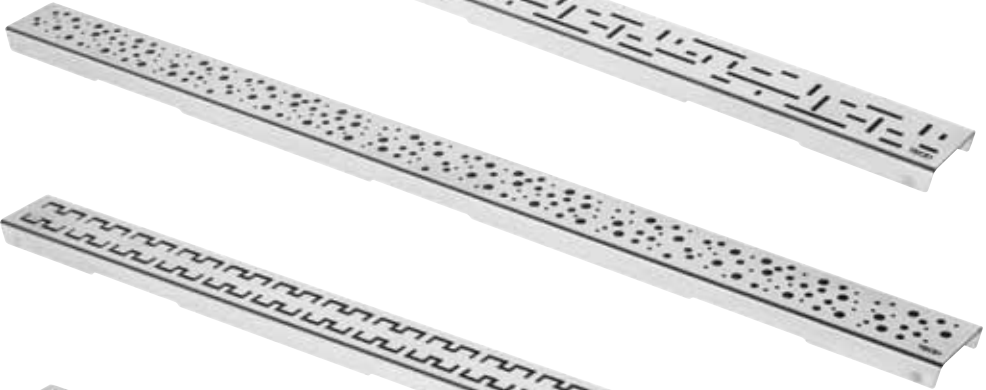

Design "royal"

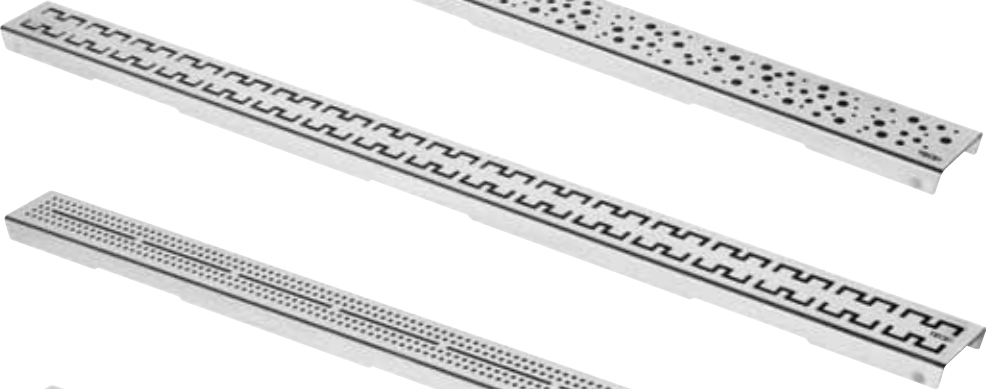

Design "quadratum"

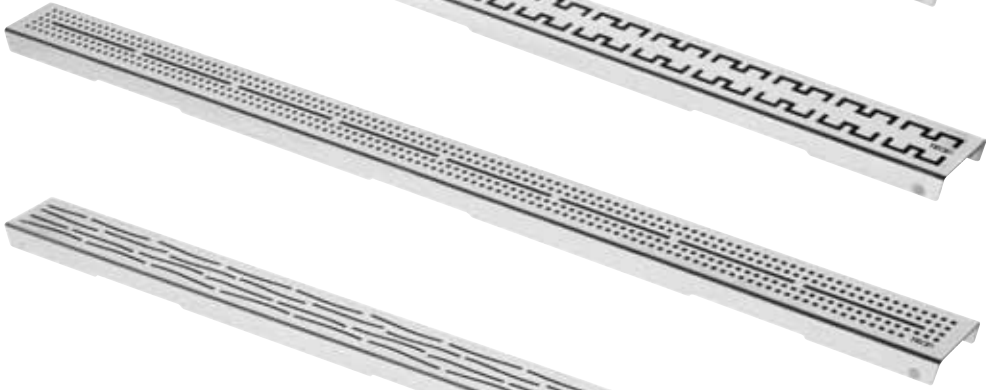

Design "organic"



Design "steel II"



- Straight lengths 700, 800, 900, 1000, 1200 and 1500 mm (system length)
- Visible width of 66 mm
- Custom lengths from 400 mm up to a maximum of 1500 mm are also available at short notice
- For straight grates, all designs can be supplied with a bright polished or brushed stainless steel surface
- For angled channels, the designs "steel II" and "basic" can be supplied with a polished stainless steel finish

The article numbers for your order and the required accessories can be found on pages 26 to 28 of this brochure.

Natural stone floors have their own unmistakeable charm. However, it is often somewhat unpractical to install a shower channel in this type of floor. TECE has therefore developed a special channel for natural stone floors that makes installation and sealing far easier. A change has been made to the appearance too: While before, narrow stainless steel edges bordered the drain opening, only a slit is now visible in the natural stone.

"Invisible" shower channel

TECE drainline channel for natural stone



TECEdrainline – new feeling of freedom in bathroom design.



TECEDrainline shower channels open up new design options in bathroom architecture – and bathroom planners take advantage of this new freedom. Thus stainless steel channels can not only be fitted between the dry and wet areas but also, for instance, directly at the wall.

Close wall installation of the TECEDrainline in the "steel II" grate design: A mere 1% gradient to the wall suffices for directing the water into the shower channel.



Standard installation of TECEDrainline in the entry to the shower as a wet-to-dry area transition featuring the "quadratum" grate design.

TECEdrainline – mounting variants

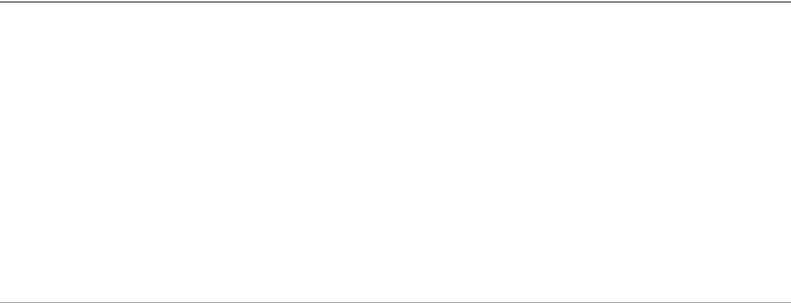

Further design options are the use of an angled channel or two parallel channels.

Installation with angled channel and the “drops” grate design.



Fitting two parallel “plate” tileable channels, which can be faced with the particular tiles.

Edge turned up by the factory saves time.

A special channel for installation at the wall immediately enhances the TECEdrainline range: The new stainless steel channel is equipped with a wall flange which has already been turned up at the factory and is available in all the standard lengths from 700 to 1500 mm. All patterned covers, mounting feet and outlets can be used without limitation. The result: particularly when there is a large number of channels to be installed at the wall, time is saved and the work on-site is minimised. The tile finishing edge of 20 mm also offers more flexibility for easier installation at the wall.

Incidentally: Nothing has changed with the standard channel. It can still be turned up on-site when needed, just as before.

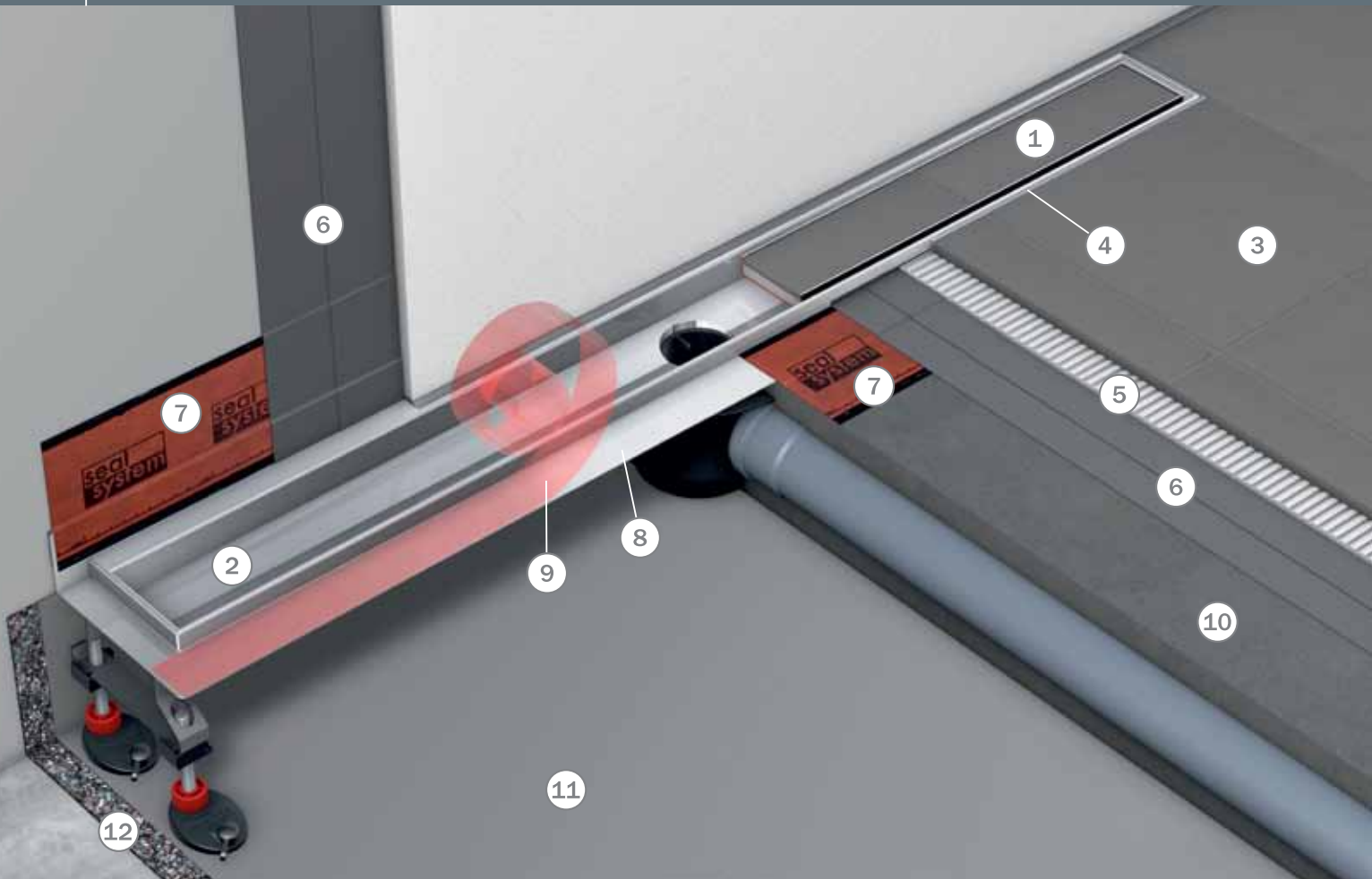

- | | | |
|-----------------------------|-----------------------------|------------------------------------|
| 1. "plate" tileable channel | 5. Tile adhesive | 9. Removable protective film |
| 2. Channel body | 6. Composite seal | 10. Screed |
| 3. Tile cover | 7. Seal System sealing tape | 11. PE foil |
| 4. Elastic grouting | 8. Channel flange | 12. Drainbase sound insulation mat |

TECEdrainline standard channel – installation



Setting the height of the horizontal channel using the assembly feet, connection of the rotatable outlet to a DN 40, DN 50 or DN 70 drain pipe.



Completely underfilling with screed produces stable anchoring of the channel body and outlet with the unfinished floor.

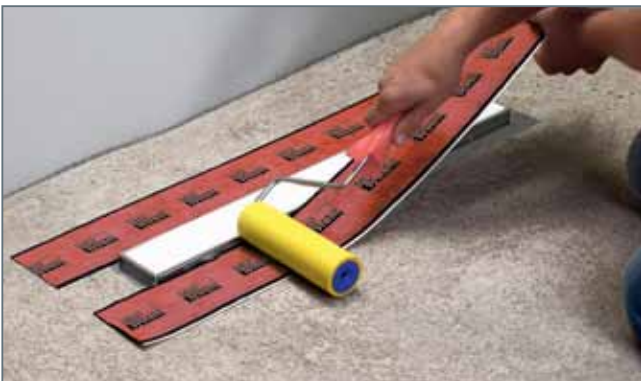

Seal System adhesive tape: the butyl adhesive tape is a self-adhesive sealant and ensures a water-tight bond between the flange and the screed.



The final step before tiling is the application of the composite seal.

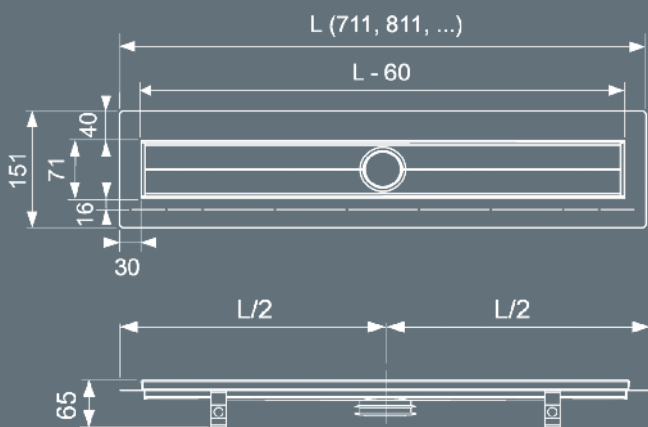

The length of the channel body is tailored to the standard dimensions of TECEdrainline grates.

- Lengths L for straight channels from 711 to 1511 mm (visible dimension after assembly L - 60 mm)
- Lengths L for angled channels from 944 x 944 to 1544 x 1544 mm (visible dimension after assembly L - 70 mm)
- Option of installation close to the wall

TECEdrainline channel for natural stone

TECEdrainline natural stone channel



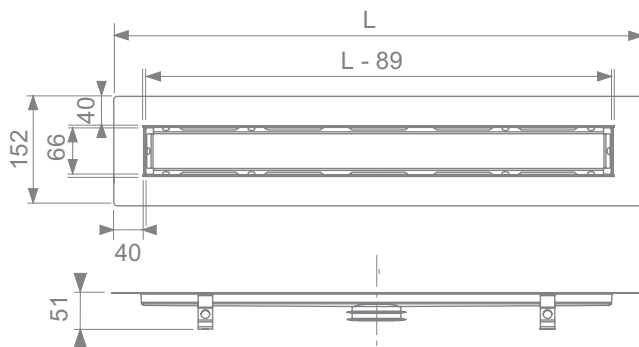



TECE has developed a special channel for natural stone floors. Consisting of a channel body with a support for the natural stone covering and a 4 centimetre wide flange around the outside. This makes installation and sealing far easier. The stone slabs can therefore be laid using both a thin-bed and thick-bed method.

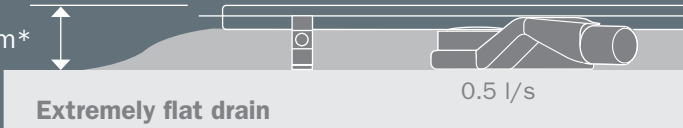

- Channel and stainless steel support as set
- Lengths L for channels from 735 to 1535 mm (visible dimension after assembly $L - 89$ mm)

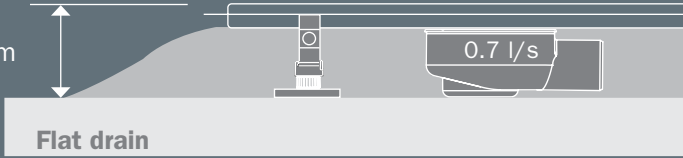
The range includes five drains for different requirements and structural features. The models match all the shower channels in the TECEdrainline range.

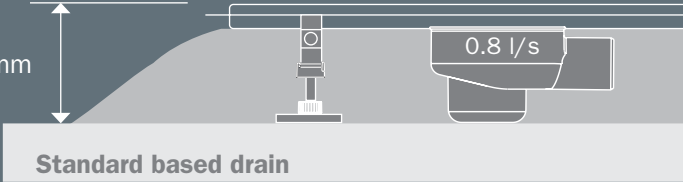
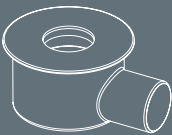
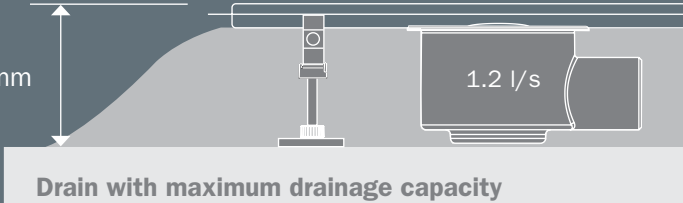
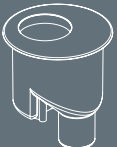
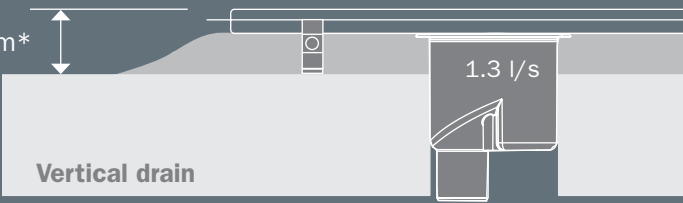
- Drain DN 40 with a particularly low assembly height of 67 mm (total assembly height to upper edge of finished floor) with 0.5 l/s drainage capacity
- DN 70 drain with particularly high drainage capacity of 1.2 l/s with standard-compliant sealing water height in accordance with DIN EN 1253, ideal for power showers
- Vertical drain for floor bushing – optionally also with fire protection set for fire resistance classes EI 120

| | | Total assembly height with upper edge of finished floor | Drain assembly height |
|-------------------|--|--|-----------------------|
| Horizontal drains |  DN 40 | min. 67 mm*  Extremely flat drain 0.5 l/s | min. 53 mm* |
| |  DN 50 | min. 95 mm  Flat drain 0.7 l/s | min. 81 mm |
| |  DN 50 | min. 120 mm  Standard based drain 0.8 l/s | min. 106 mm |
| |  DN 70 | min. 148 mm  Drain with maximum drainage capacity 1.2 l/s | min. 134 mm |
| Vertical drains |  DN 50 | min. 65 mm*  Vertical drain 1.3 l/s | min. 51 mm* |
| |   | ■ FireStop fire protection set for the vertical drain With the FireStop fire protection set for TECEdrainline shower channels, TECE is offering safety with fire protection – up to fire resistance class EI 120 in accordance with DIN EN 13501-3. | |

* without assembly feet

Seal System – certified safety

Seal System – the new sealing standard for TECEdrainline shower channels

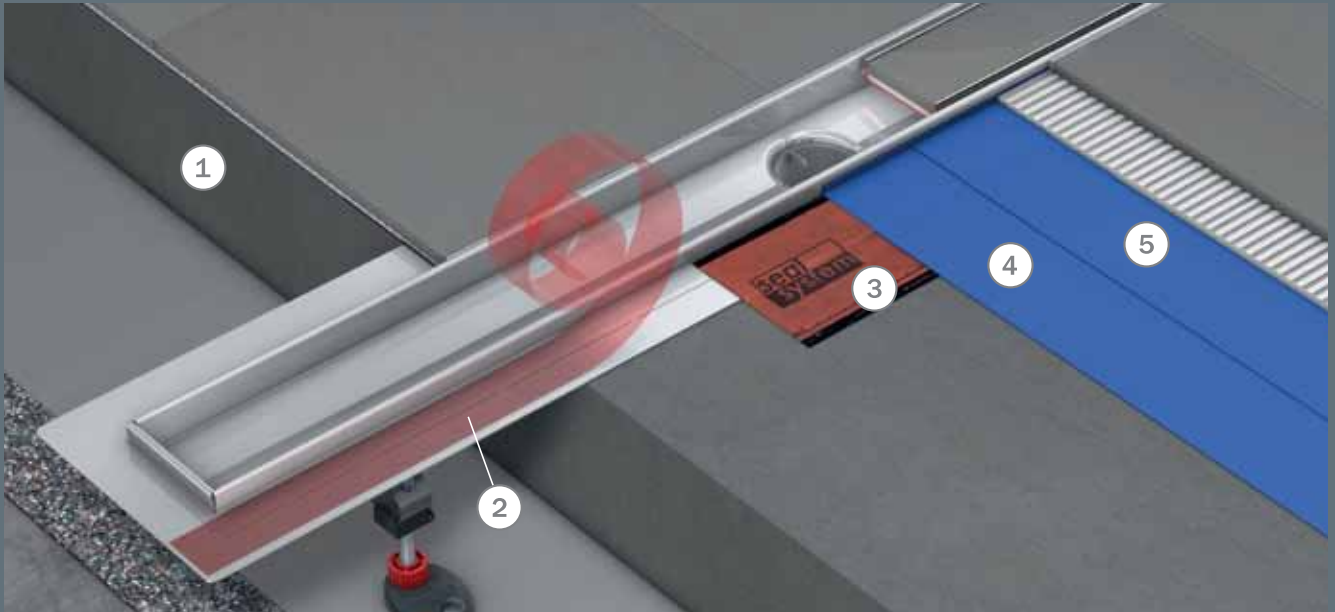

Example of Seal System sealing of a TECEdrainline shower channel with a certified sealing product: (1) screed, (2) channel flange protective film, (3) Seal System sealing tape, (4) first layer of composite seal, (5) second layer of composite seal.

What is Seal System?

Seal System offers TECE installers and tilers tested safety when connecting composite seals to TECEdrainline shower channels and TECEdrainpoint S floor drains. The testing was done by the independent testing institute Kiwa TBU, and was performed according to the building authorities test criteria applicable in Germany (PG-AIV).

More than 50 sealing products from well-known manufacturers were successfully tested and certified. For this purpose, the functional safety (water-tightness) of the composite sealing products was tested with the TECE drainage products. A certificate is available for each product which passed the test.

A list of all the certified composite seals can be called up at www.sealsystem.net.



The TECEdrainline Seal System consists of the following components:

1. TECEdrainline shower channel with universal flange
2. Seal System sealing tape
3. One of the 50 tested and certified sealing products

The new standard reference work on composite sealing

Assured planning and handling of composite seals at the shower channel and point drain

A standard work on composite sealing: Point. Line. Sealed! tells you all about certified composite seals in book form. Experienced practitioners from the trade and industry have gathered all there is to know about composite seals in 272 pages.

Point. Line. Sealed!



The new standard reference work on composite sealing

The new 272-page standard reference work on certified composite sealing. Packed with information to help with the planning and installation of sealing systems in sanitary facilities, notes on the waterproofing of buildings and floor structures incorporating drainage solutions, more than 100 basic testing certificates issued by Kiwa TBU in Greven relating to point and linear drains and explanatory notes on the relevant standards. Point. Line. Seal! by Martin Krabbe, Reinhold P. Bäder et al. Can be obtained from booksellers and on the Internet under ISBN 978-3-00-040275-3 at the price of 36 euros incl. VAT.

Problem: risk of leachate drain

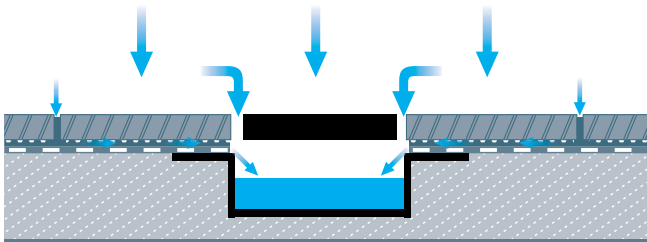

Pure theory: Those promoting secondary drains of the mortar layer believe that water will flow below the tiles and has to be drained.

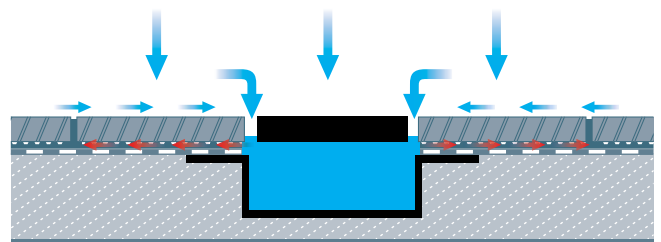

In practice: The water rising from the shower channel during a shower flushes dirt particles into cavities and below the tile edge due to capillary effects. Odour development threatens!

ERROR no. 1 Tiles have a functional task and guide-water to the drain across a slope. The decisive sealing level is below them.

FACT: The standard designation of current bonded seals is „sealing in combination with tiles and plates“. This makes clear that the tile surface is the sealing level surface by definition. The idea of secondary

this is usually due to frost damage.

ERROR no. 3 If leachate collects below the tiles, it must be drained through an additional drainage level.

FACT: Damaged joints may permit water to enter in theory – but can it enter below the tiles as well? Not really. There is no defined drainage path either.

Fiction and fact: the seven most common misconceptions regarding shower channel and secondary drainage

drainage originates in times in which bituminous sealing strips were used for sealing below the screed. The mortar layer between the tile and bonded seal cannot and need not be drained in the shower area.

ERROR no. 2 When joints lose their sealing capacity, water will enter, damage the tile adhesive and cause tiles to come off.

FACT: The water volumes that enter here are in the range of homeopathic quantities. The quality of current joint materials reliably prevents moistening. When joints or tiles break, the moisture that enters evaporates through the entry opening. All common tile adhesives are also suitable for the placement of tiles at the pool floor or on terraces. In contrast to showers, they are always wet. If tiles on terraces come lose,

A single transverse layer of tile adhesive is sufficient to prevent water from draining. Leachate can only drain if there are channels below the tiles. Such channels do not exist.

ERROR no. 4 Leachate drain makes shower channels safer.

FACT: The opposite is the case. In contrast to closed and jointless channel bodies reaching to the edge of the tile (diagram page 25 top), the leachate drain openings pose the danger of dandruff, soap residue and hair settling and even collecting in the cavities due to the capillary effects (diagram page 24 top). A shower channel fills during a shower and the leachate openings come into contact with the shower water in the channel – with the negative consequences

TECEdrainline – The subject of "Secondary Drainage"

Solution: channel body close to the tile edge

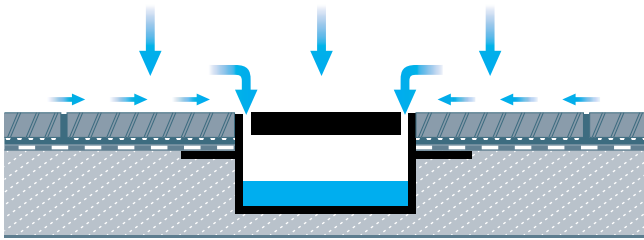

The TECEdrainline shower channel principle: Seamless, homogeneously closed channel bodies are easy to clean and securely tight.

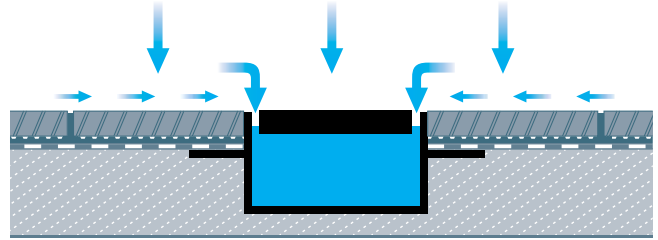

In the shower: There is no capillary effect even when water does rise – the homogeneously closed channel body shows its advantages here.

described above. For channels that are performed without tile edges for visual reasons, the area between the channel body and the tile must be permanently sealed.

ERROR no. 5 *Leachate will cause efflorescence or discoloration in natural stone.*

FACT: Efflorescence or discolorations in natural stone are not caused by water but usually by unsuitable embedding or joint material. True efflorescence that may occur outdoors due to weather does not occur in the shower area.

ERROR no. 6 *Leachate openings are needed as ventilation openings so that the tile adhesive can dry in particular under large tiles.*

FACT: Tile adhesives cure cement-based. The chemical reaction works even if there is no air supply. If leachate openings were required to ventilate the mortar layer, large tiles would only be permitted along shower channels.

ERROR no. 7 *Shower channels are hard to clean and tend to develop an odour.*

FACT: Jointless and closed channel bodies of stainless steel like those offered by TECE are easy to clean and without corners or cavities that cannot be reached. They also contain no screws or thread parts on which dirt or hair might catch.

In particular the leachate-drain that is sometimes demanded contains such difficult zones: The micro-biological disintegration of organic material in such shower channels may cause the formation of smells that will, in the worst case, require high renovation effort.



Unworldly: Move the notched trowel in the other direction once and the leachate drain will be blocked.



Easy to clean: Only „seamless and homogeneously closed channel body“ shower channels are actually easy to clean.



Efflorescence: Natural stone does not discolour due to leachate. If it does anyway, it is due to the wrong embedding or joint material.



Sealing: The victory of the shower channel has made the seal in combination with the shower tiles popular again.

How to order:

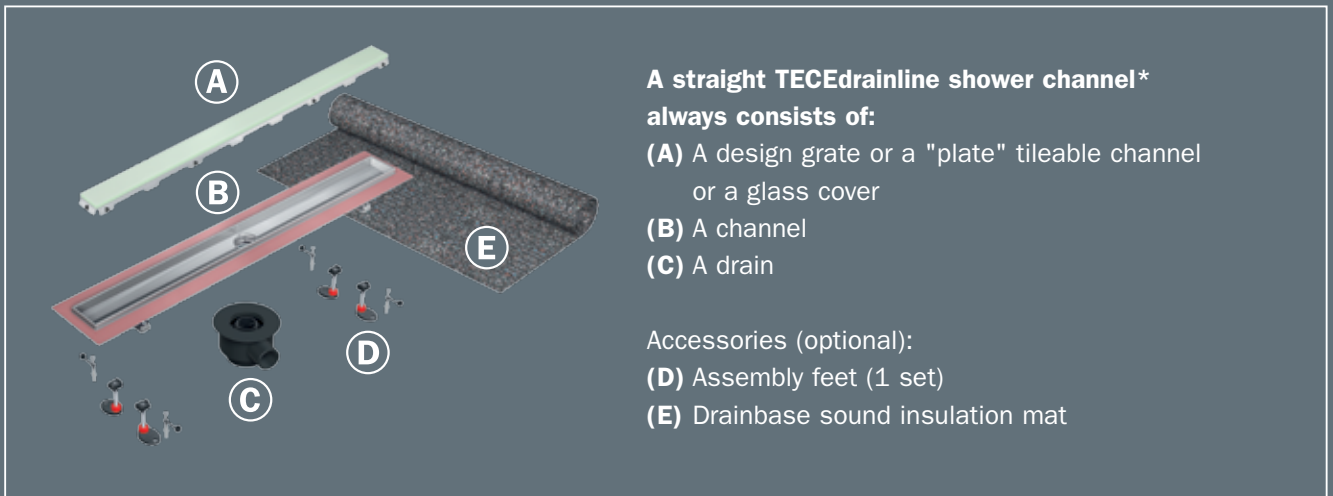

*The natural stone channel is supplied with stainless steel support. The design grates and "plate" (A) tileable channel are not suitable for the natural stone channel.

A

Straight grates, polished or brushed stainless steel, tileable channel, glass covers

| Nominal length | | 700 mm | 800 mm |
|-----------------------------|----------|-----------|-----------|
| Grate, channel, glass cover | Surface | Order No. | Order No. |
| "basic" | polished | 6 007 10 | 6 008 10 |
| | brushed | 6 007 11 | 6 008 11 |
| "lines" | polished | 6 007 20 | 6 008 20 |
| | brushed | 6 007 21 | 6 008 21 |
| "drops" | polished | 6 007 30 | 6 008 30 |
| | brushed | 6 007 31 | 6 008 31 |
| "royal" | polished | 6 007 40 | 6 008 40 |
| | brushed | 6 007 41 | 6 008 41 |
| "quadratum" | polished | 6 007 50 | 6 008 50 |
| | brushed | 6 007 51 | 6 008 51 |
| "organic" | polished | 6 007 60 | 6 008 60 |
| | brushed | 6 007 61 | 6 008 61 |
| "steel II" | polished | 6 007 82 | 6 008 82 |
| | brushed | 6 007 83 | 6 008 83 |
| "plate" | polished | 6 007 70 | 6 008 70 |
| "plate II" | polished | 6 007 72 | 6 008 72 |
| Glass green | Glass | 6 007 90 | 6 008 90 |
| Glass white | Glass | 6 007 91 | 6 008 91 |
| Glass black | Glass | 6 007 92 | 6 008 92 |

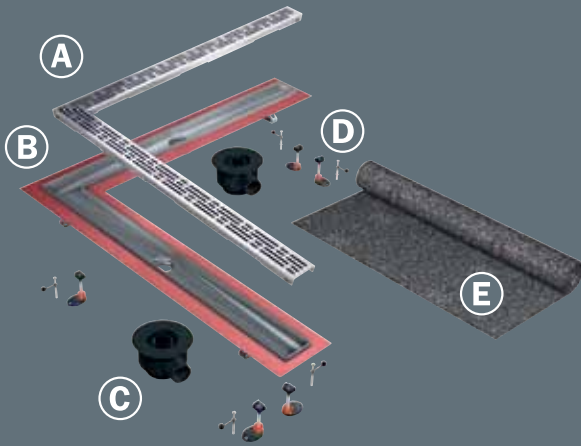

An angled TECEdrainline angled shower channel always consists of:

- (A)** A design grate or a "plate" tileable channel
- (B)** A channel
- (C)** Two drains

Accessories (optional):

- (D)** Assembly feet (2 sets)
- (E)** Drainbase sound insulation mat

Angled grates 90°, polished stainless steel, tileable channel



| 900 mm | 1000 mm | 1200 mm | 1500 mm | 900/900 mm | 1000/1000 mm | 1200/1200 mm | 1500/1500 mm |
|-----------|-----------|-----------|-----------|------------|--------------|--------------|--------------|
| Order No. | Order No. | Order No. | Order No. | Order No. | Order No. | Order No. | Order No. |
| 6 009 10 | 6 010 10 | 6 012 10 | 6 015 10 | 6 109 10 | 6 110 10 | 6 112 10 | 6 115 10 |
| 6 009 11 | 6 010 11 | 6 012 11 | 6 015 11 | – | – | – | – |
| 6 009 20 | 6 010 20 | 6 012 20 | 6 015 20 | – | – | – | – |
| 6 009 21 | 6 010 21 | 6 012 21 | 6 015 21 | – | – | – | – |
| 6 009 30 | 6 010 30 | 6 012 30 | 6 015 30 | – | – | – | – |
| 6 009 31 | 6 010 31 | 6 012 31 | 6 015 31 | – | – | – | – |
| 6 009 40 | 6 010 40 | 6 012 40 | 6 015 40 | – | – | – | – |
| 6 009 41 | 6 010 41 | 6 012 41 | 6 015 41 | – | – | – | – |
| 6 009 50 | 6 010 50 | 6 012 50 | 6 015 50 | – | – | – | – |
| 6 009 51 | 6 010 51 | 6 012 51 | 6 015 51 | – | – | – | – |
| 6 009 60 | 6 010 60 | 6 012 60 | 6 015 60 | – | – | – | – |
| 6 009 61 | 6 010 61 | 6 012 61 | 6 015 61 | – | – | – | – |
| 6 009 82 | 6 010 82 | 6 012 82 | 6 015 82 | 6 109 82 | 6 110 82 | 6 112 82 | 6 115 82 |
| 6 009 83 | 6 010 83 | 6 012 83 | 6 015 83 | – | – | – | – |
| 6 009 70 | 6 010 70 | 6 012 70 | 6 015 70 | 6 109 70 | 6 110 70 | 6 112 70 | 6 115 70 |
| 6 009 72 | 6 010 72 | 6 012 72 | 6 015 72 | | | | |
| 6 009 90 | 6 010 90 | 6 012 90 | 6 015 90 | | | | |
| 6 009 91 | 6 010 91 | 6 012 91 | 6 015 91 | | | | |
| 6 009 92 | 6 010 92 | 6 012 92 | 6 015 92 | | | | |

Custom lengths and exclusive designs

We will be happy to produce custom lengths up to 1500 mm or a grate design to suit your own specifications. We will advise you of the costs when you submit your enquiry. Delivery time: 4–6 weeks from approval and clarification of all details. Custom lengths and custom finishes cannot be cancelled after approval is given, and may not be returned. Maximum length to order: 1500 mm.

B

Channels with Seal System sealing tape

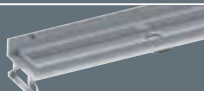
| | | | | | | | |
|---|---------------------------------------|------------|-----------|--------------|--------------|--------------|-----------|
| | Nominal length | 700 mm | 800 mm | 900 mm | 1000 mm | 1200 mm | 1500 mm |
| | Visible dimensions after installation | 651 mm | 751 mm | 851 mm | 951 mm | 1151 mm | 1451 mm |
| Straight channels  | Order No. | Order No. | Order No. | Order No. | Order No. | Order No. | Order No. |
| | | 6 007 00 | 6 008 00 | 6 009 00 | 6 010 00 | 6 012 00 | 6 015 00 |
| | Nominal length | 900/900 mm | | 1000/1000 mm | 1200/1200 mm | 1500/1500 mm | |
| | Visible dimensions after installation | 874/874 mm | | 974/974 mm | 1174/1174 mm | 1474/1474 mm | |
| Angled channels 90°  | Order No. | Order No. | Order No. | Order No. | Order No. | Order No. | |
| | | 6 109 00 | 6 110 00 | 6 112 00 | 6 115 00 | | |
| | Nominal length | 700 mm | 800 mm | 900 mm | 1000 mm | 1200 mm | 1500 mm |
| | Visible dimensions after installation | 648 mm | 748 mm | 848 mm | 948 mm | 1148 mm | 1448 mm |
| Straight channels for natural stone with stainless steel support as set  | Order No. | Order No. | Order No. | Order No. | Order No. | Order No. | Order No. |
| | | 6 507 00 | 6 508 00 | 6 509 00 | 6 510 00 | 6 512 00 | 6 515 00 |
| | Nominal length | 700 mm | 800 mm | 900 mm | 1000 mm | 1200mm | 1500 mm |
| | Visible dimensions after installation | 651 mm | 751 mm | 851 mm | 951 mm | 1151 mm | 1451 mm |
| Channel with wall upstand for installation at the wall  | Order No. | Order No. | Order No. | Order No. | Order No. | Order No. | Order No. |
| | | 6 007 01 | 6 008 01 | 6 009 01 | 6 010 01 | 6 012 01 | 6 015 01 |



C

Drains

| | Assembled height | Drainage capacity | Order No. |
|---|------------------|-----------------------|-----------|
| DN 40 Extremely flat drain  | 67 mm** | 0,5 l/s 0,6 l/s*** | 6 500 04 |
| DN 50 Flat drain  | 95 mm* | 0.7 l/s | 6 500 00 |
| DN 50 Standard drain  | 120 mm* | 0.8 l/s | 6 500 01 |
| DN 70 Max. drain  | 148 mm* | 1.5 l/s | 6 500 02 |
| DN 50 Vertical drain  | 65 mm** | 1.4 l/s | 6 500 03 |

* Total assembled height with channel, ** channel without assembly feet, *** without immersion pipe

Membrane odour trap

| | Order No. |
|--|-----------|
| For extremely flat drain  | 6 600 15 |
| For flat drain and standard  | 6 600 16 |
| For max. and vertical drains  | 6 600 17 |

Other

| | Order No. |
|--|-----------|
| Hair trap TECEdrainline for insert into the channel body  | 6 600 05 |
| FireStop fire protection set (EI 120) for vertical drain DN 50  | 6 600 06 |
| Seal System sealing tape for TECEdrainline, self-adhesive, roll 10 m  | 6 600 14 |



D

Assembly feet, set of 4 pcs.

| | Order No. |
|--|-----------|
| Assembly feet 92-139 mm  | 6 600 03 |
| Assembly feet 137-184 mm  | 6 600 04 |

E

Drainbase sound insulation mat

| | Order No. |
|---|-----------|
| 1250 x 1250 mm Material thickness 6 mm  | 6 600 01 |
| Roll L = 8 m/W = 1250 mm, Material thickness 6 mm  | 6 600 02 |

TECEdrainline – easy to clean and hygienic

Cleaning and hygiene

The drainage channel is made of stainless steel, is closed without corners or cavities which cannot be reached, and there are no screws or threaded components on which hair or dirt can be trapped. It is therefore hygienic and easy to clean. If the outlet should ever become blocked, the immersion pipe can be removed (2nd fig. from right) and a conventional cleaning coil can be used to clear the blockage. A marking on the inside of the drain shows the location of the drain outlet for this purpose.



Penetrating odour? Not a chance!

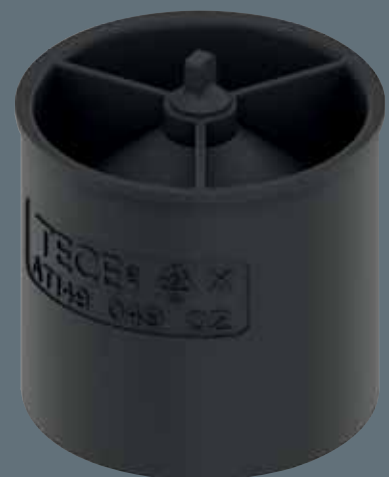
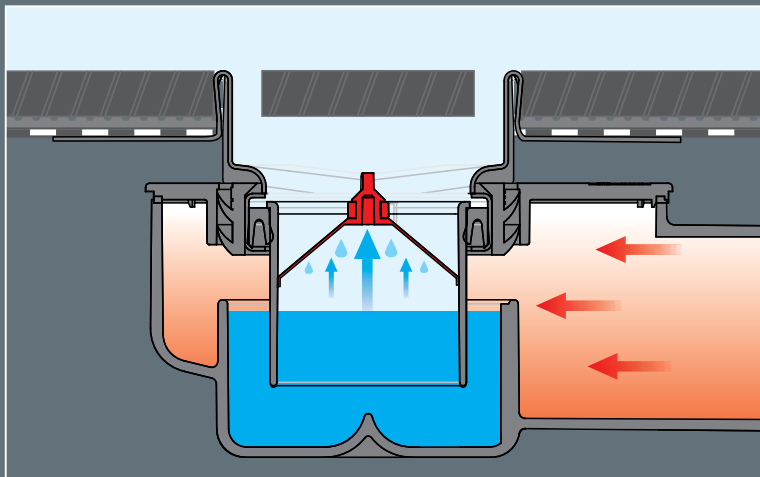

The two-stage TECEdrainline membrane odour trap

Odours produced in seldom-used sanitary equipment because the odour trap has dried out? TECEdrainline membrane odour trap tackles the problem in an innovative way: The immersion pipe of the odour trap has a sealing lip membrane on the inside. This membrane minimises the evaporation of the sealing water - unpleasant odours cannot arise. The system can be retro-fitted to any TECE shower channel and also acts as a barrier against vermin and foam.

Drainage technology to a standard – made by TECE.

TECE is one of the few manufacturers to have allowed their drainline shower channel to be tested by the LGA Würzburg according to the applicable standards for drainage equipment inside buildings. This means more product liability security for planners and installers. Among those things tested were the drainage capacity, sealing water height and temperature resistance of the different drains; the load-bearing capacities of the grates were also part of the test.*



* The grates "plate" and "basic" were tested in combination with the standard, vertical and max. drains.

TECE GmbH
International Business
Phone +49 (0) 25 72 / 928 999
international-business@tece.de
www.tece.com



Visit us on the Internet and assemble your desired channel online using the shower channel configurator at www.tece.com.



DS060 000 60 d

TECE:
Intelligent housing technology